





INSTRUCTIONS FOR:
**1/4" HEX DRIVE DIGITAL TORQUE
SCREWDRIVER .05-5Nm**
MODEL No: **STS103**

Thank you for purchasing a Sealey product. Manufactured to a high standard, this product will, if used according to these instructions, and properly maintained, give you years of trouble free performance.

  **IMPORTANT:** PLEASE READ THESE INSTRUCTIONS CAREFULLY. NOTE THE SAFE OPERATIONAL REQUIREMENTS, WARNINGS & CAUTIONS. USE THE PRODUCT CORRECTLY AND WITH CARE FOR THE PURPOSE FOR WHICH IT IS INTENDED. FAILURE TO DO SO MAY CAUSE DAMAGE AND/OR PERSONAL INJURY AND WILL INVALIDATE THE WARRANTY. KEEP THESE INSTRUCTIONS SAFE FOR FUTURE USE.

1. SAFETY

- X Ensure all workshop safety rules, regulations and conditions are complied with when using this tool.
- ✓ Maintain the screwdriver in good condition.
- X The screwdriver is a precision tool, **DO NOT** drop it or abuse it.
- ✓ Maintain correct balance and footing. Ensure the floor is not slippery and wear non-slip shoes.
- ✓ Keep children and unauthorised persons away from the working area.
- ☐ **WARNING! DO NOT** use the screwdriver if damaged or thought to be faulty.
- ✓ After use, clean and store in a safe, dry, childproof location.

2. INTRODUCTION

Suitable for automotive, workshop and factory use. LCD read-out with LED, audible alarm and vibration indicating achieved and target torque levels. Preset track, peak or desired torque levels using simple push-button menu. Clockwise and anti-clockwise operation. Selectable read-out in Nm or lb.ft. Accurate to ±2% of stated capacity. Textured, contoured handle for added grip and comfort. Supplied with test certificate.

3. SPECIFICATION

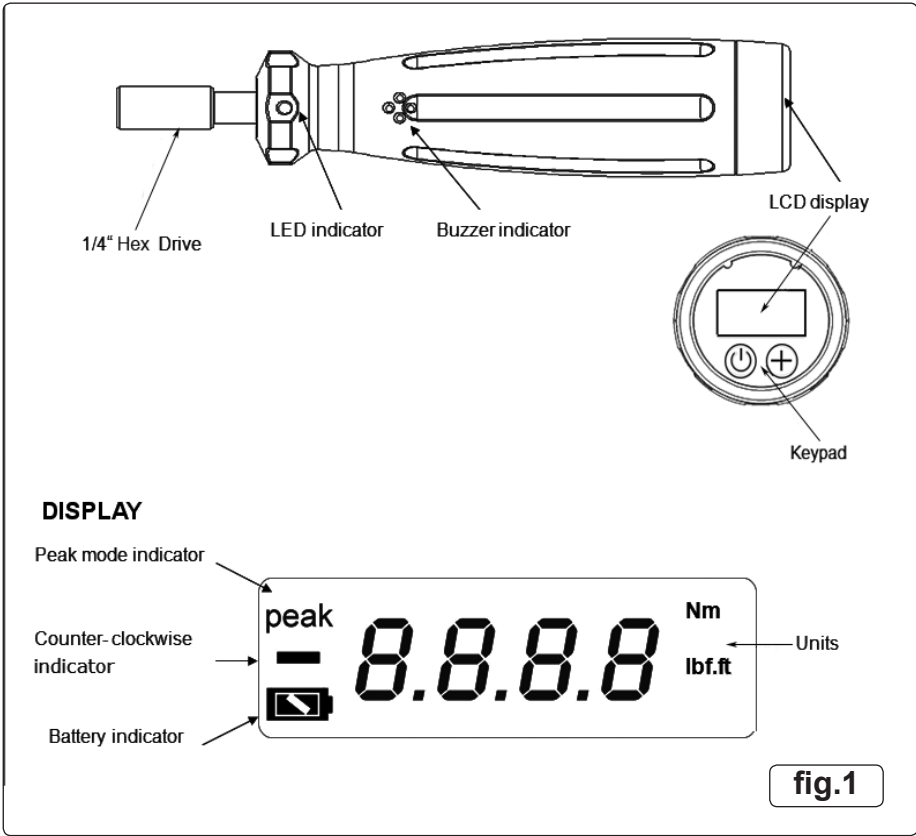

Model No: **STS103**
Drive: 1/4" Hex
Range:05-5Nm
Length: 155mm
Batteries: 2 x AAA (supplied)



KEYPAD



FUNCTION KEYS

1.  : Press to turn the screwdriver on/Press and hold the button for 5 seconds to alter the display units/ In measurement mode, press to zero.
2.  : Press to enter SETTING mode and press to increase the value to programme pre-set torque.

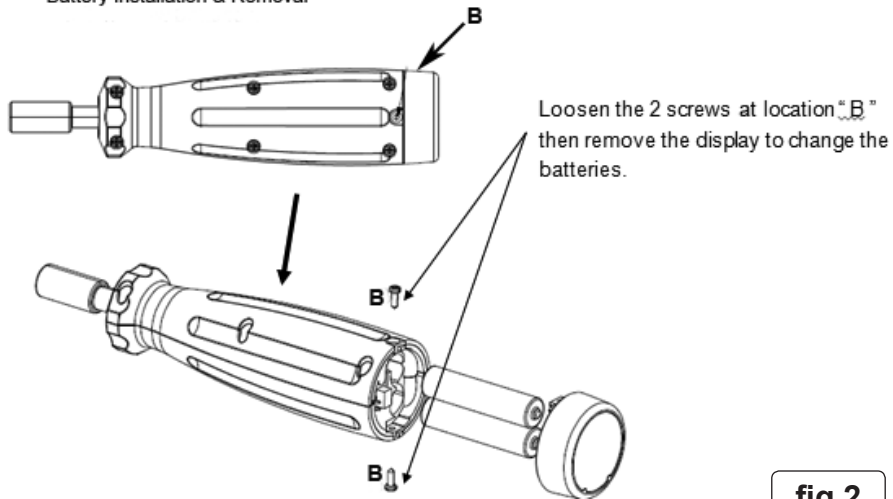

PREPARATION:

Battery Installation & Removal



4. SETTING



4.1. Turning the tool on / off (see figs 1 & 2)

- 4.1.1. Press  button to turn on. The buzzer sounds and on the display shows all the readouts simultaneously. After 3 seconds the display shows "0000" on the screen.
- 4.1.2. Under torque measuring mode, press  button again to turn the electronic system off.
- 4.1.3. The screwdriver will turn off automatically without any buttons being pressed, or inactivity over 2 minutes.

4.2. Check battery charge level indicator:

If the battery is empty, the indicator on the display will show , an entirely white battery symbol. The batteries must be replaced in order to guarantee full function and accuracy.





4.3. Activating the Track Mode:

- 4.3.1. After turning on the display, the default is in "Peak" mode, the maximum value reached will be saved additionally and the value is shown on the display for approx. 2 seconds. After that, this value flashes and then you can continue to the next application or press  button to zero.
- 4.3.2. During the "Track" mode, the real-time torque reached during operation will be displayed.
- 4.3.3. To select either "Track" or "Peak" mode, first press:  and, within 3 seconds: .

4.4. Unit Selection:

With the unit switched on, press and hold  for 5 seconds to switch between Nm and lb/ft.

4.5. Programming the Pre-set Torque Value.

- 4.5.1. Press and hold the  button for 3 seconds to enter the setting mode. Release the button when "SEt" is shown on the screen.
- 4.5.2. Press  button to increase the pre-set torque. Note: In the setting mode, the display will **NOT** show peak on the left side of the screen.
- 4.5.3. To increase the value, keep the button pressed to increase the rate of increase.
- 4.5.4. To decrease the value, press  to zero the display, then press  to increase to the required value.
- 4.5.5. Once the target torque has been selected, the screwdriver will memorise that torque after 3 seconds.
- 4.5.6. If a target torque of more than 100% maximum torque value (5Nm) is selected, the display will zero and no setting will be entered.

5. OPERATION

- 5.1. After applied force, the maximum value reached will be saved additionally and the value is shown on the display for approx. 2 seconds. If the target torque is reached, the buzzer will sound, the LED indicator will light and the handle will vibrate for approx. 2 seconds.
 - 5.2. This value will continue flashing allowing the reading to be used for the next application. Alternatively, the  button may be pressed to zero the reading before the next application.
 - 5.3. When force is applied in an anticlockwise direction, the display will show a minus (-) sign on the left side of screen. The following reading will be positive when clockwise torque is applied.
 - 5.4. The meter will switch off automatically after approx. 2 minutes of inactivity.
- CAUTION: DO NOT** use the screwdriver when the battery level is low. An inaccurate reading is possible in this condition

6. CARE

- 6.1. **DO NOT** apply force when the power is turned off.
- 6.2. **DO NOT** expose the unit to strong magnetic fields, corrosive agents, excessive heat or humidity.
- 6.3. Clean only with a damp cloth, do not use proprietary cleaners or solvents to clean this product.
- 6.4. If it is anticipated that the screwdriver will be out of use for a time, the batteries should be removed (fig.2).
- 6.5. When not in use, store in a cool, dry location away from direct sunlight and out of the reach of children.

Environmental Protection



Recycle unwanted materials instead of disposing of them as waste. All tools, accessories and packaging should be sorted, taken to a recycling centre and disposed of in a manner which is compatible with the environment. When the product becomes completely unserviceable and requires disposal, drain off any fluids (if applicable) into approved containers and dispose of the product and the fluids according to local regulations.



WEEE Regulations

Dispose of this product at the end of its working life in compliance with the EU Directive on Waste Electrical and Electronic Equipment (WEEE). When the product is no longer required, it must be disposed of in an environmentally protective way. Contact your local solid waste authority for recycling information.

Battery Removal



For battery removal, see fig.2.

Under the Waste Batteries and Accumulators Regulations 2009, Jack Sealey Ltd are required to inform potential purchasers of products containing batteries (as defined within these regulations), that they are registered with Valpak's registered compliance scheme. Jack Sealey Ltd's Batteries Producer Registration Number (BPRN) is BPRN00705.

Parts support is available for this product. To obtain a parts listing and/or diagram, please log on to www.sealey.co.uk, email sales@sealey.co.uk or telephone 01284 757500.

NOTE: It is our policy to continually improve products and as such we reserve the right to alter data, specifications and component parts without prior notice.



IMPORTANT: No liability is accepted for incorrect use of this product.



WARRANTY: Guarantee is 12 months from purchase date, proof of which will be required for any claim.

INFORMATION: For a copy of our latest catalogue and promotions call us on 01284 757525 and leave your full name and address, including postcode.



Sole UK Distributor, Sealey Group,
Kempson Way, Suffolk Business Park,
Bury St. Edmunds, Suffolk,
IP32 7AR

 01284 757500
 01284 703534

 www.sealey.co.uk
 sales@sealey.co.uk